

Star Hub Kit

Exploring Archimedean Polyhedra

Living Architecture Systems Group

This folio accompanies a construction kit that has been developed by the Living Architecture Systems Group employing soft, resilient star-shaped socket joints combined with short push-in struts. By combining arrays of these joints and struts, many kinds of geometric organizations can be easily explored.

The particular forms supported by this construction system include transitions between closed, hardened shells and open membranes. The patterns included here relate to the intricate skeletal systems that can be found in the microscopic worlds of living nature. Colloids and manifolds are intermediary forms that occur at transitions between states of solid, fluid, and gas. Within those worlds may be found hardened spherical shells and faceted crystals as well as flowing membranes and floating, open structures (1). By developing tangible form languages based on these transitional kinds of forms, new generations of designers may be able to find renewed ways for working effectively with far-from-equilibrium environments.

Downloadable 3d printable patterns and assembly instructions are included within this publication, supported by open-source Creative Commons licensing that permits adaptation and extension of the construction kit.

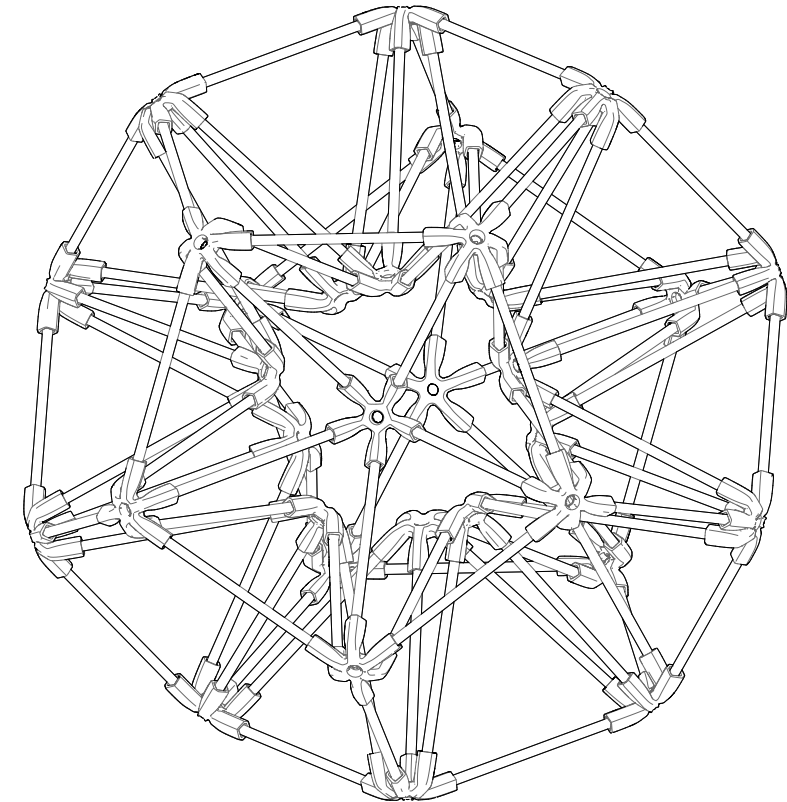

Star Hub Kit

EXPLORING ARCHIMEDEAN POLYHEDRA

LIVING ARCHITECTURE SYSTEMS GROUP

ISBN 978-1-988366-43-2



9 781988 366432
Riverside Architectural Press

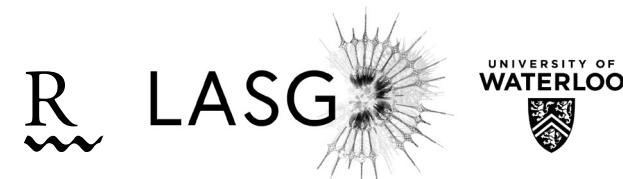

Star Hub Kit

Exploring Archimedean Polyhedra

Living Architecture Systems Group



Publisher: Riverside Architectural Press, www.riversidearchitecturalpress.ca
© Riverside Architectural Press and Living Architecture Systems Group 2022

Title: Star Hub Kit: Exploring Archimedean Polyhedra
Names: Beesley, Philip, 1956-editor. | Living Architecture Systems Group, issuing body.

Description: Series statement: Living Architecture Systems Group folio series | Edited by Philip Beesley. | Includes Index.

Identifiers: ISBN 978-1-988366-43-2

Production: Philip Beesley, Timothy Boll, Adrian Chiu, Kevan Cress, Lisa Jiang, Ruth Jones, Abida Rahman, Rekha Ramachandran

Publication: December 2022
Riverside Architectural Press
11 Dublin Street

Printed in Toronto, Canada.

All rights reserved.

The individual authors shown herein are solely responsible for their content appearing within this publication. CC BY-NC-SA: This license allows reusers to distribute, remix, adapt, and build upon the material in any medium or format for noncommercial purposes only, and only so long as attribution is given to the creator. If you remix, adapt, or build upon the material, you must license the modified material under identical terms.

Errors or omissions will be corrected in subsequent editions.

This book is set in Garamond and Zurich BT.



Social Sciences and Humanities
Research Council of Canada

Conseil de recherches en
sciences humaines du Canada

About the Living Architecture Systems Group

The publication forms part of a series of work-in-progress reports and publications by Living Architecture researchers and contributors. The Living Architecture Systems Group is an international partnership of researchers, artists, and industrial collaborators studying how we can build living architectural systems— sustainable, adaptive environments that can move, respond, and learn, and that are inclusive and empathic toward their inhabitants. “Smart” responsive architecture is rapidly transforming our built environments, but it is fraught with problems including sustainability, data privacy, and privatized infrastructure. These concerns need conceptual and technical analysis so that designers, urban developers and architects can work positively within this deeply influential new field.¹ The Living Architecture Systems Group is developing tools and conceptual frameworks for examining materials, forms, and topologies, seeking sustainable, flexible, and durable working models of living architecture.

A series of far-reaching critical questions can be explored by using the tools and frameworks that are described within this specialized publication series: can the buildings that we live in come alive? Could living buildings create a sustainable future with adaptive structures while empathizing and inspiring us? These questions can help redefine architecture with new, lightweight physical structures, embedded sentient and responsive systems, and mutual relationships for occupant that provide tools and frameworks to support the emerging field of living architecture. The objective of this integrated work envisions embodied environments that can provide tangible examples in order to shift architecture away from static and inflexible forms towards spaces that can move, respond, learn, and exchange,² becoming adaptive and empathic toward their inhabitants.³

1 Kas Oosterhuis and Xin Xia, *iA #1, Interactive Architecture* (Rotterdam: Episode Publishers, 2007); Nicholas Negroponte, *Being Digital* (New York: Vintage Books, 1995); Lucy Bullivant, *4dsocial: Interactive Design Environments* (London: AD/John Wiley & Sons, 2007); Neil Spiller, *Digital Architecture Now: A Global Survey of Emerging Talent* (London: Thames & Hudson, 2009); Michael Fox and Miles Kemp, *Interactive Architecture* (Princeton: Princeton Architectural Press, 2009).

2 For example the Living Architecture (LIAR) next-generation, selectively programmable bioreactor developed by LASG Metabolism Stream Lead Rachel Armstrong, Newcastle, uses microbial processes to generate electricity, oxygen, fertiliser, and other life-sustaining outputs from waste (carbon dioxide, grey water) that would otherwise be ejected from a building: “Living Architecture LIAR,” accessed February 2, 2022, <https://livingarchitecture-h2020.eu/>.

3 Bullivant, *4dsocial*.

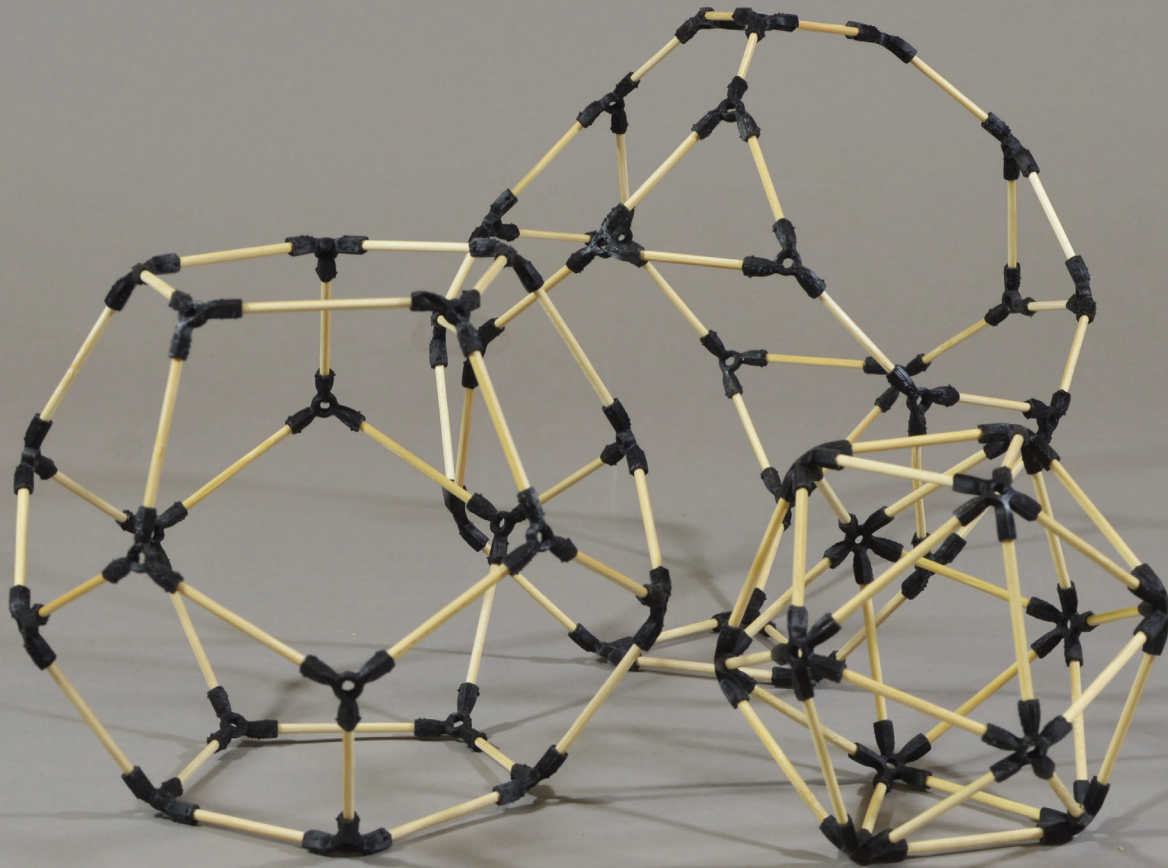

Contents

1	Introduction
3	Kit Components
4	Geometry Assemblies
	Truncated Tetrahedron
	Cuboctahedron
	Icosahedron
	Icosidodecahedron
	Truncated Icosidodecahedron
	Tiled Surface
	Waffle
	Crenellated Membrane
21	References
22	Credits

Introduction

This folio contains a selection of patterns that supports exploration of many different kinds of geometric organizations. This kit employs soft, resilient joints that can support many kinds of intermediate forms, revealing transitions between closed, hardened shells and open membranes. Scaffold patterns can take the form of spheres, trusses, towers, and other experimental shells, surfaces and tessellations. These structures can feature lace-like membranes and interconnected space trusses employing duplicated units.

Many of the symmetrical polyhedron constructions that appear within this construction series correspond to Archimedean Polyhedra, ancient forms that have been studied throughout Western culture. These relate to the series of elemental forms described by the Greek philosopher-mathematician Archimedes. These primary elements include triangles, squares, pentagons and hexagons that can be multiplied in increasingly complex ways in order to form spherical and shell forms.

The specific patterns included here relate to the intricate skeletal systems that can be found in the microscopic worlds of living nature.⁴ Within those worlds may be found hardened spherical shells and faceted crystals as well as flowing membranes and floating, open structures. By developing designs based on these transitional kinds of forms, new generations of designers may be able to find renewed ways for working effectively with far-from-equilibrium environments.

⁴ David Dreame and Jack W. Szostak, *The Origins of Life* (New York: Cold Spring Harbor Laboratory Press, 2010).

Large-scale interconnected arrays in both virtual and physical forms can be easily constructed by extending the system components that are provided in this kit. The structures that are documented here include filamentary triangulated skeletal frameworks for highly efficient waffle, shell and spherical envelopes. Qualities that can be observed include minimal material use and compliant structures that are capable of accommodating multiple components and evolving functions.

The scaffolds are intended for low cost and wide accessibility, and are constructed from commonly available, lightweight efficient materials. These details include bamboo skewers and 3D printed flexible hub connectors. You are welcome to duplicate these designs for your personal non-commercial use, following the open-source license terms shown.



Fabrication patterns for the components may be obtained by following the links provided here.

<http://media.lasg.ca/starhub/>



Additional patterns may be found in the Living Architecture Systems Group Folio publication entitled Archimedean Solids. That publication may be downloaded for free at the following link:

<https://livingarchitecturesystems.com/publication/geometry-kit/>

Kit Components

TPE Stars



Tri



Quad



Pent



Hex



Hept



Oct



Nona



Deca

Bamboo Struts





3cm

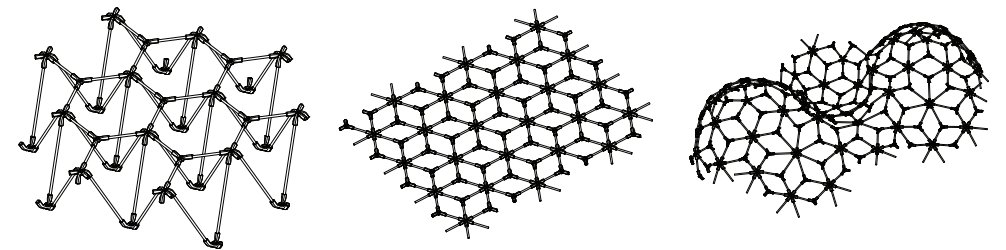
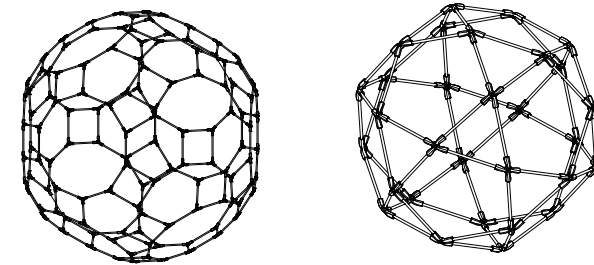
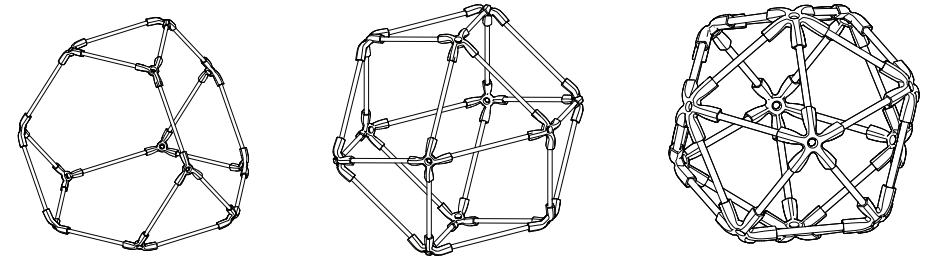

6cm

Geometry Assemblies



 x 12
 x 18

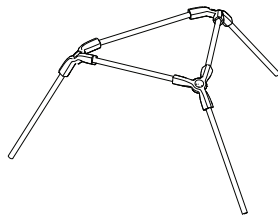

1 Start with 3 tri hubs connected by 6 bamboo struts

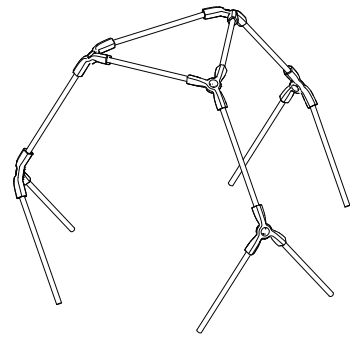

2 Build out 3 more tri hubs and extend empty sockets with bamboo struts

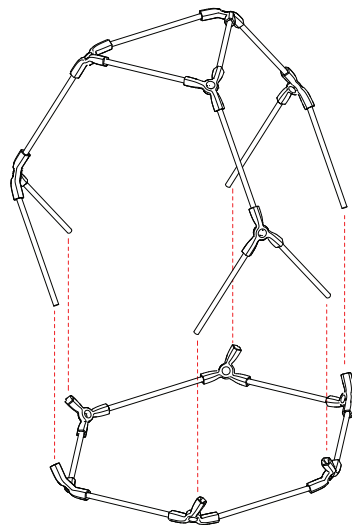

3 Assemble 6 tri hubs connected by 6 bamboo struts, join together with assembly from step 2

Truncated Tetrahedron Assembly

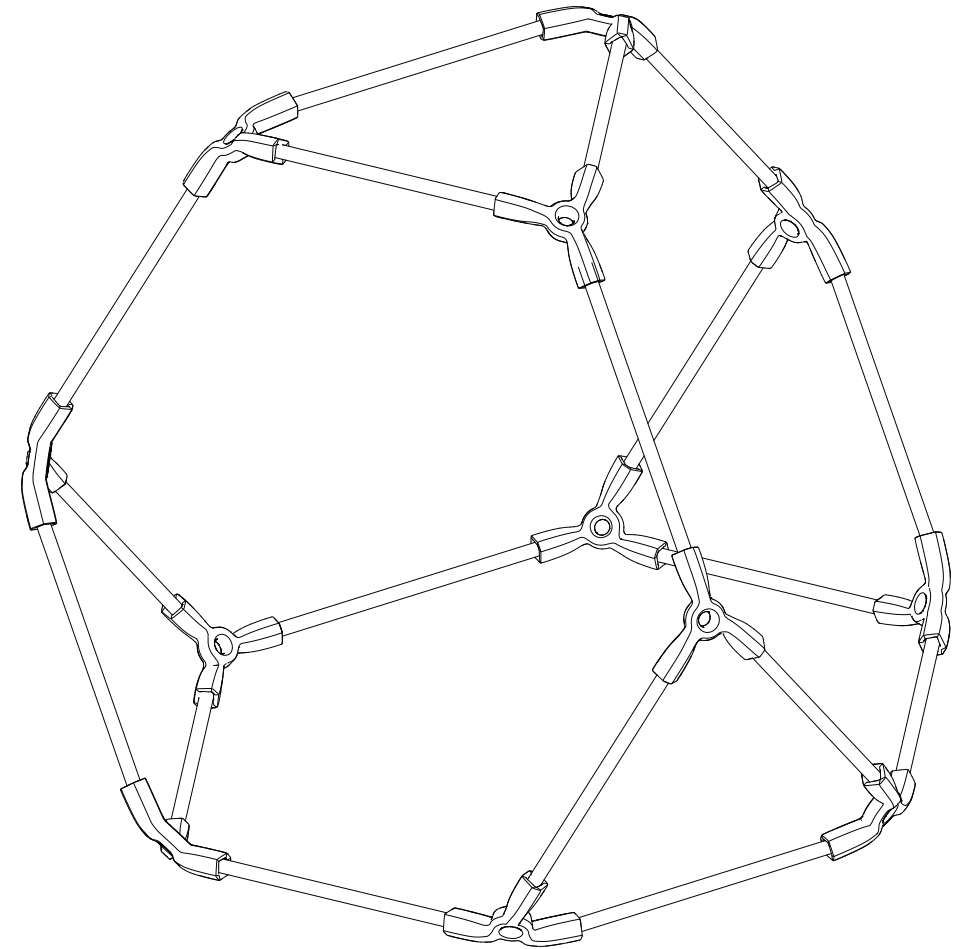

Truncated Tetrahedron

⊕ x 12
— x 24

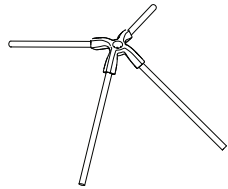

1 Start with a quad hub surrounded by 4 bamboo struts

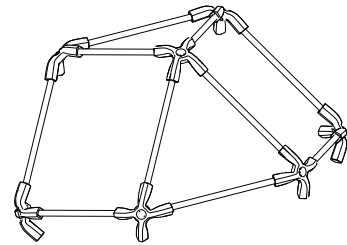

2 Build out with 4 more quad hubs and 6 bamboo struts

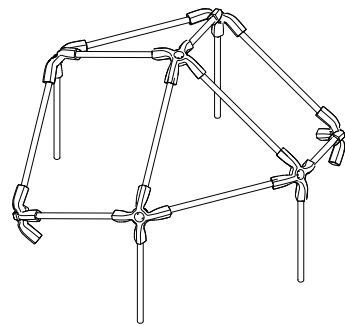

3 Build out with 2 more quad hubs and extend 4 of the empty quad hub sockets with bamboo struts

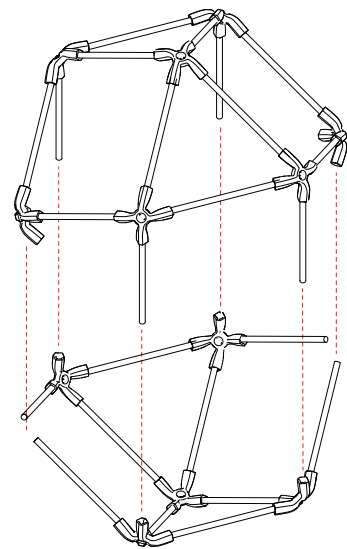

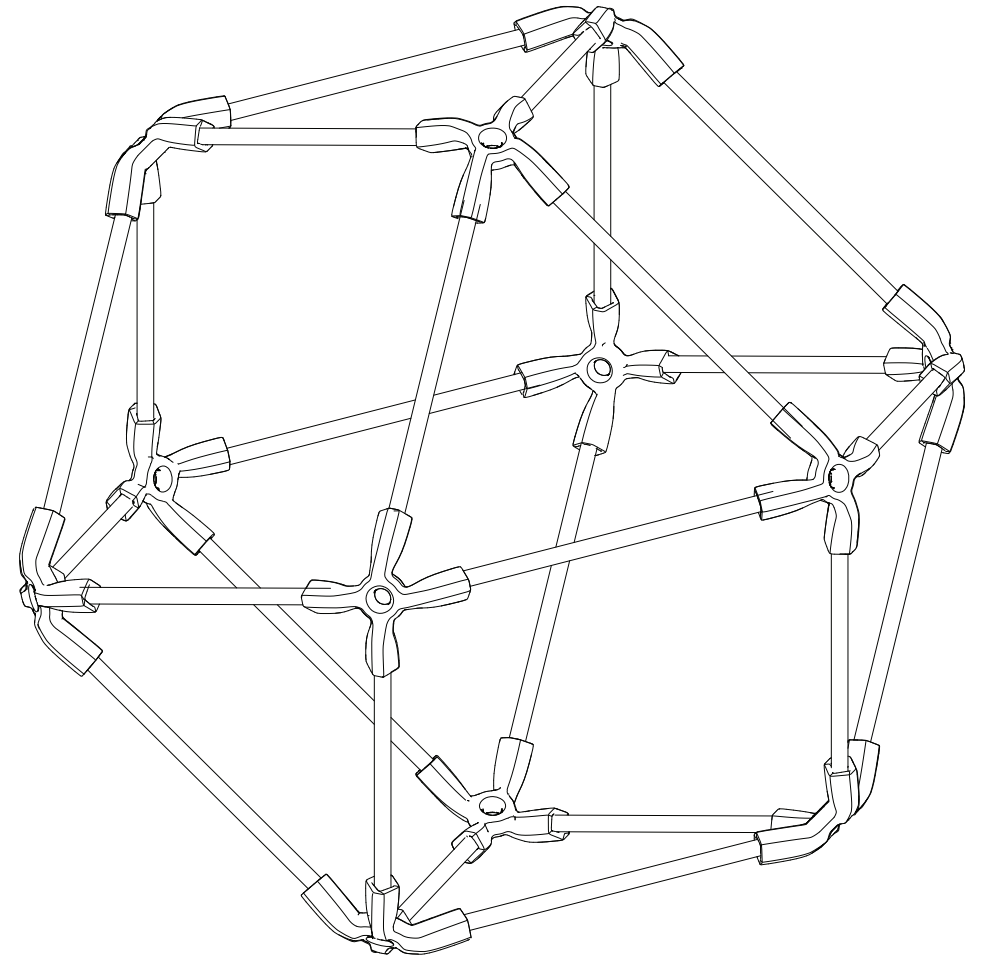

4 Join together assemblies from steps 2 and 3



Cuboctahedron Assembly

Cuboctahedron

 x 12
 x 20

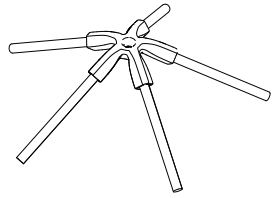

1 Start with a pent hub surrounded by 5 bamboo struts

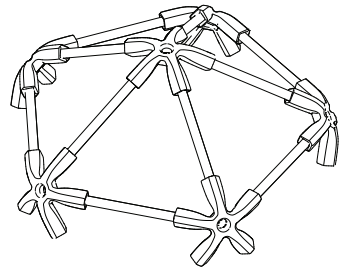

2 Build out with 5 more pent hubs and 5 bamboo struts

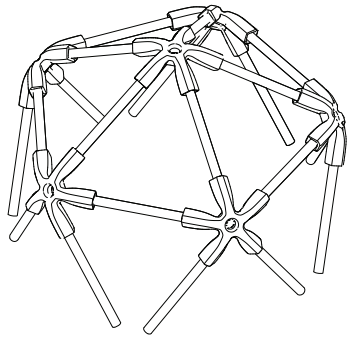

3 Extend empty pent hub sockets with 10 bamboo struts

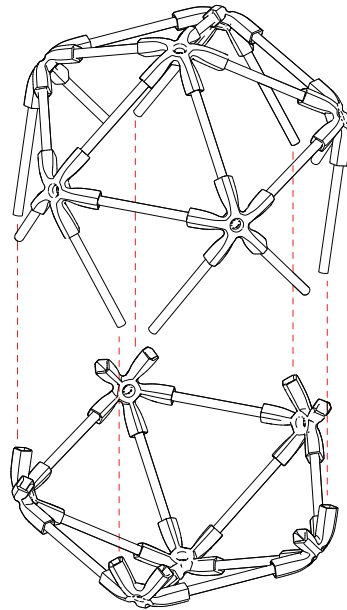

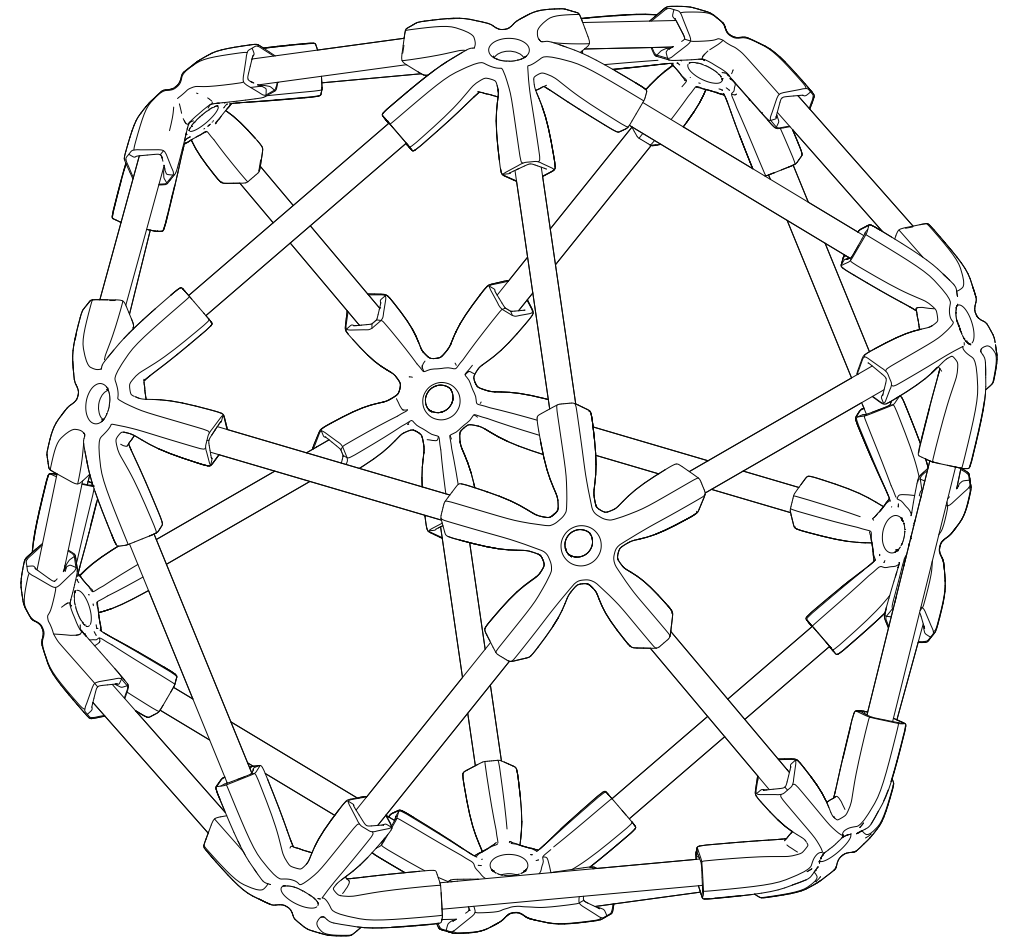

4 Join together assemblies from steps 2 and 3



Icosahedron Assembly

Icosahedron

 x 30
 x 60

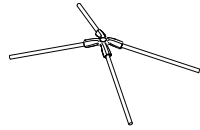

1 Start with a quad hub surrounded by 4 bamboo struts

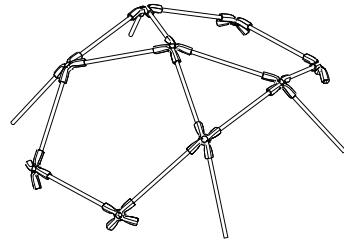

2 Build out with 8 more quad hubs and 12 bamboo struts

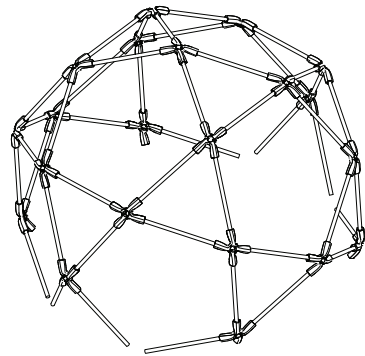

3 Build out with 12 more quad hubs and extend empty quad hub sockets with bamboo struts

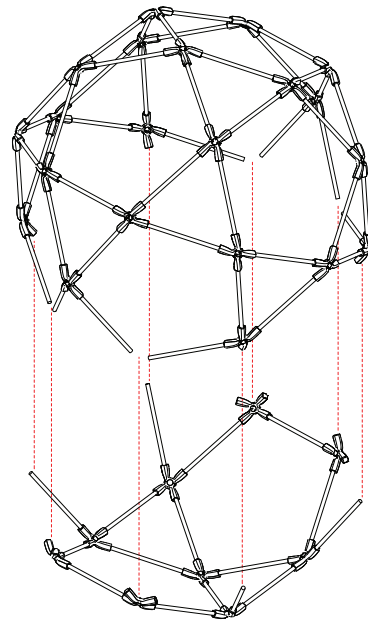

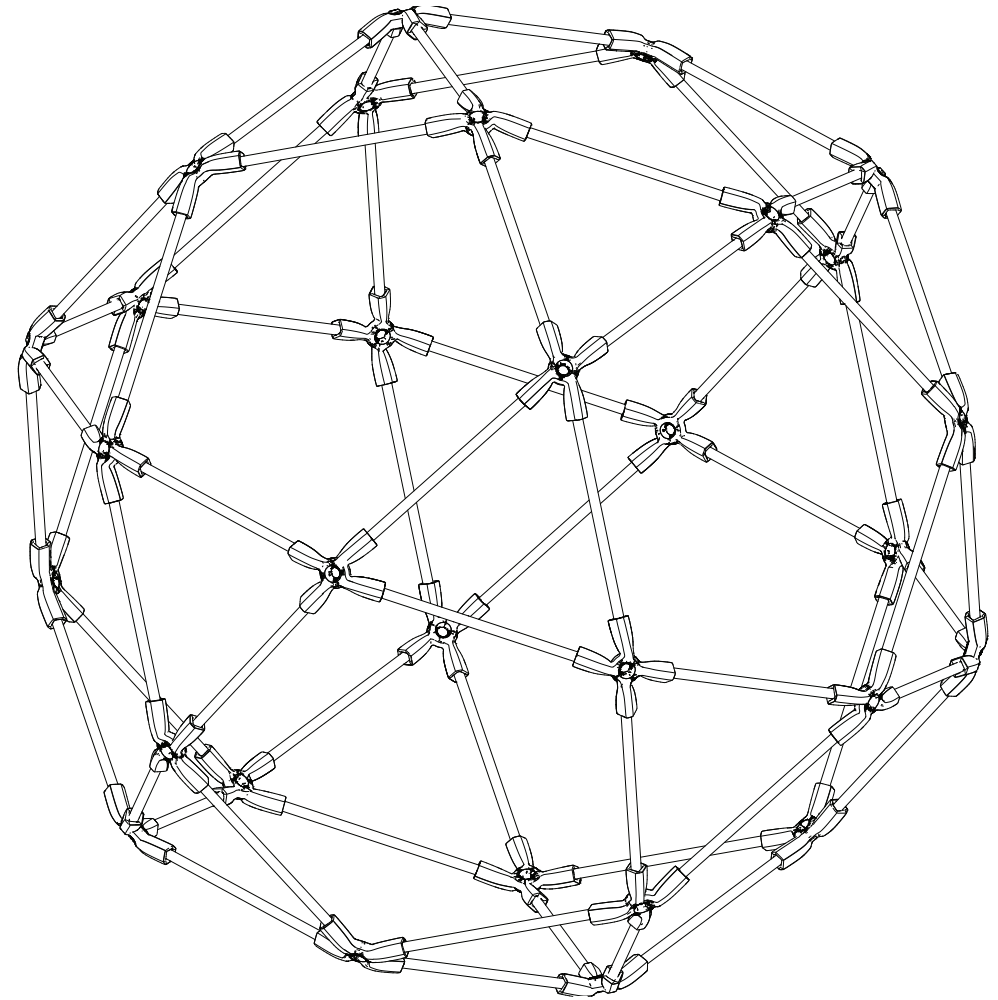

4 Join together assemblies from steps 2 and 3



Icosidodecahedron Assembly

Icosidodecahedron

 x 120
 x 180

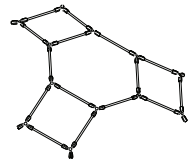

1 Start with 6 tri hubs and bamboo struts assembled into a hexagon, build out 6 more tri hubs and bamboo struts into 3 squares surrounding the hexagon

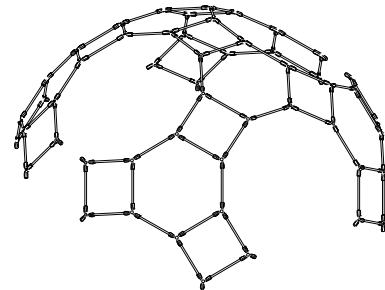

2 Extend empty tri sockets with bamboo struts to build out hexagons surrounded by 3 squares each

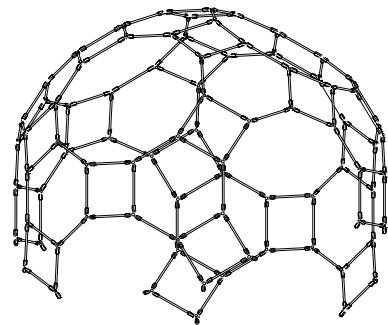

3 Continue building out this pattern of hexagons surrounded by 3 squares, forming decagon voids

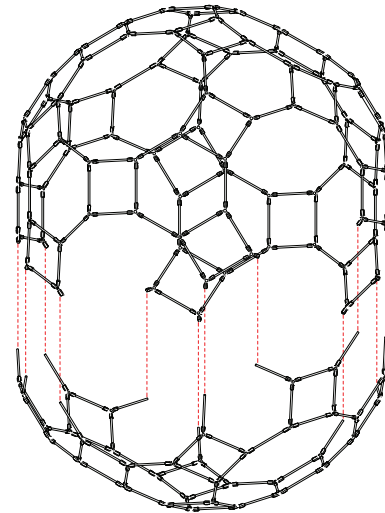

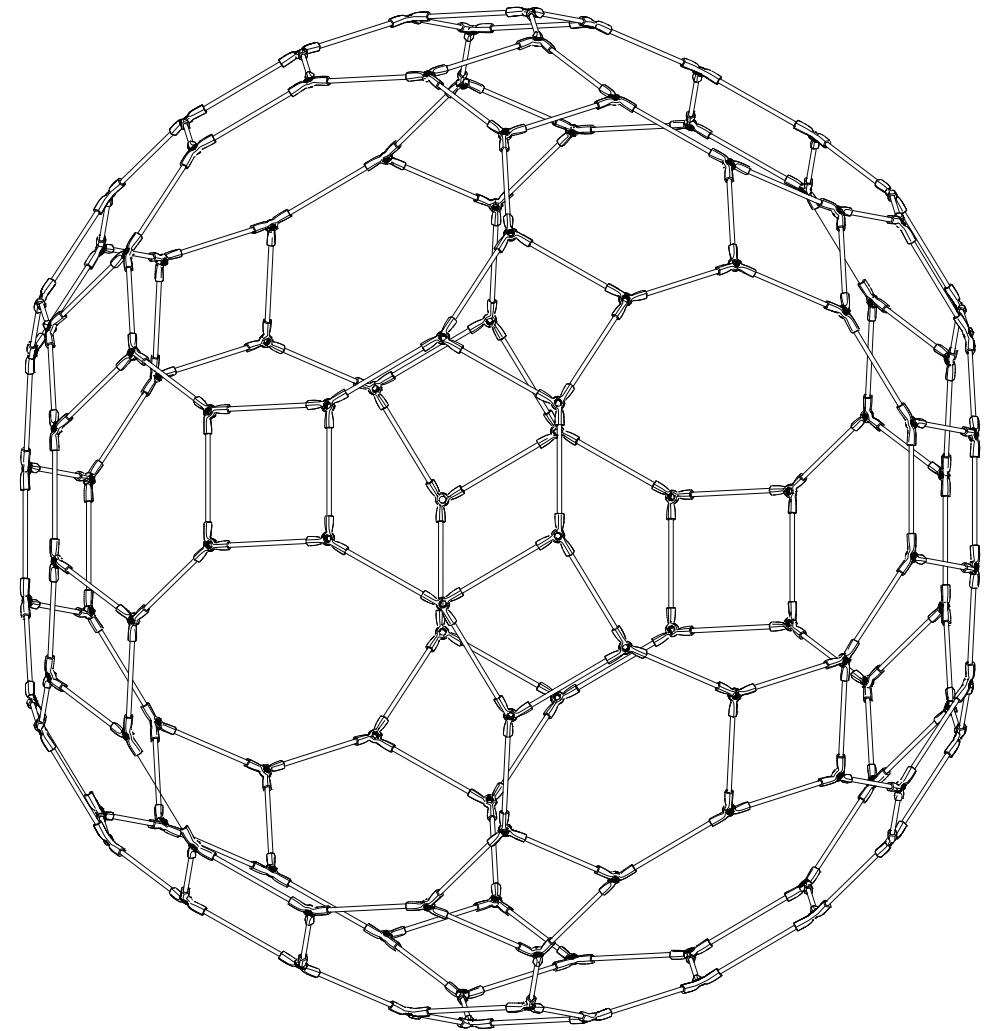

4 Extend empty tri hub sockets with bamboo struts, join together assemblies from steps 2 and 3



Truncated Icosidodecahedron Assembly

Truncated Icosidodecahedron

-  x 24
-  x 46
-  x 144

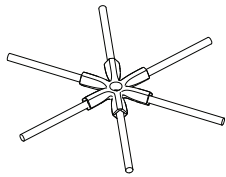

1 Start with a hex hub surrounded by 6 bamboo struts

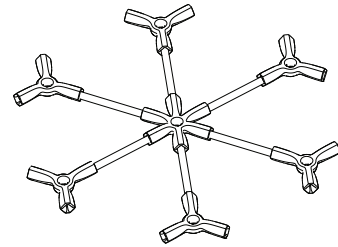

2 Build out with 5 more tri hubs at the ends of the bamboo struts

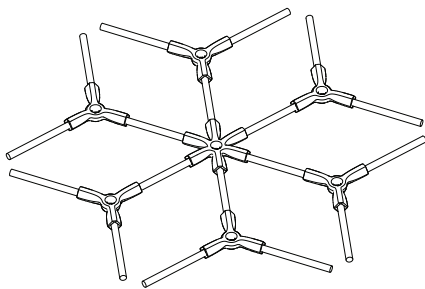

3 Extend the empty tri hub sockets with 12 bamboo struts

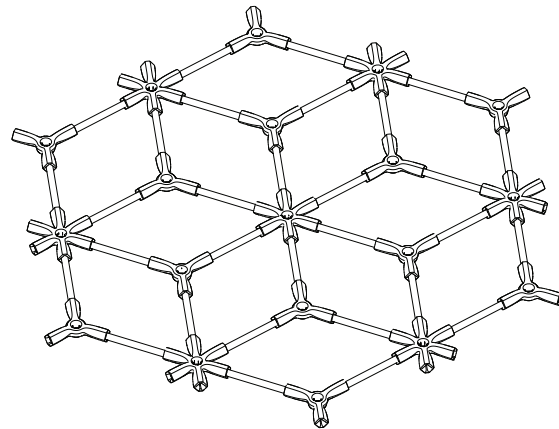



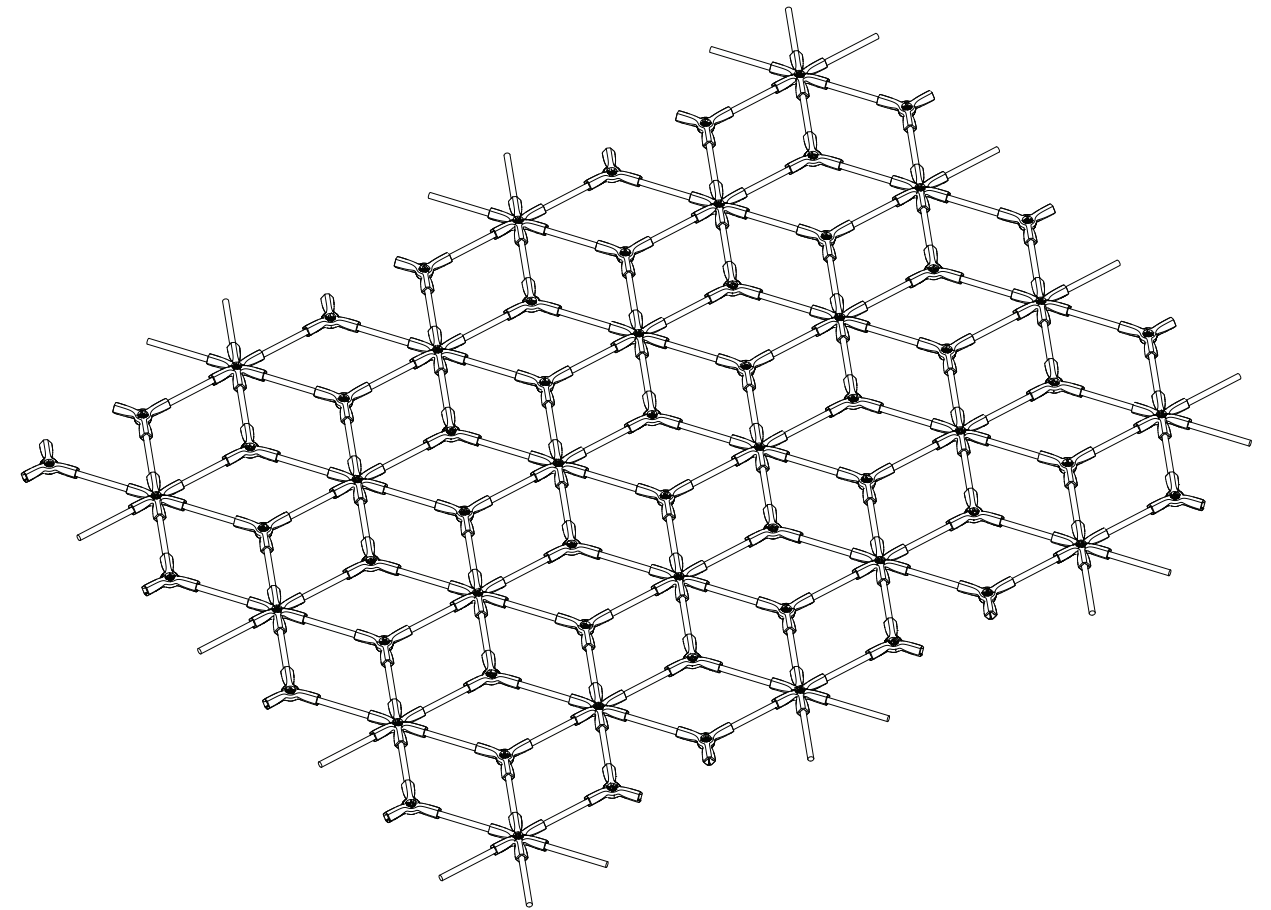

4 Build out 6 hex hubs and extend empty hex hub sockets with bamboo struts and tri hubs



Tiled Surface Assembly

Tiled Surface

-  x 19
-  x 12
-  x 21
-  x 30

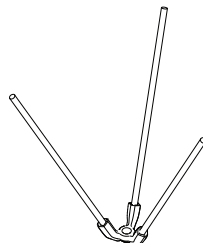

1 Start with a tri hub surrounded by three 6cm bamboo struts

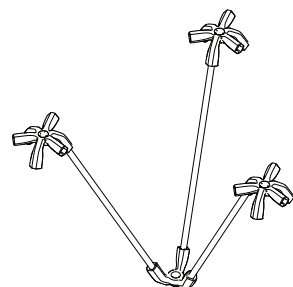

2 Build out with 3 hex hubs at the ends of the bamboo struts

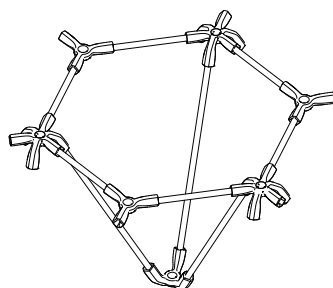

3 Connect the hex hubs to 3 tri hubs using six 3cm bamboo struts

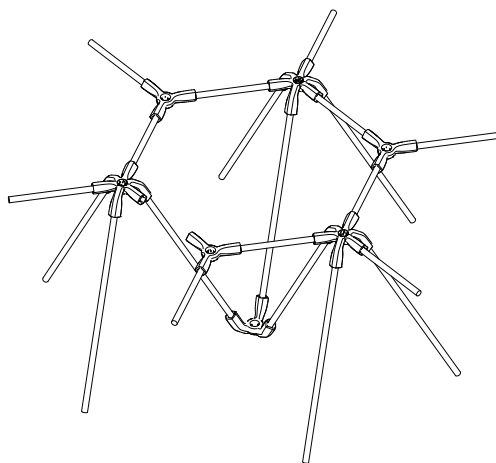



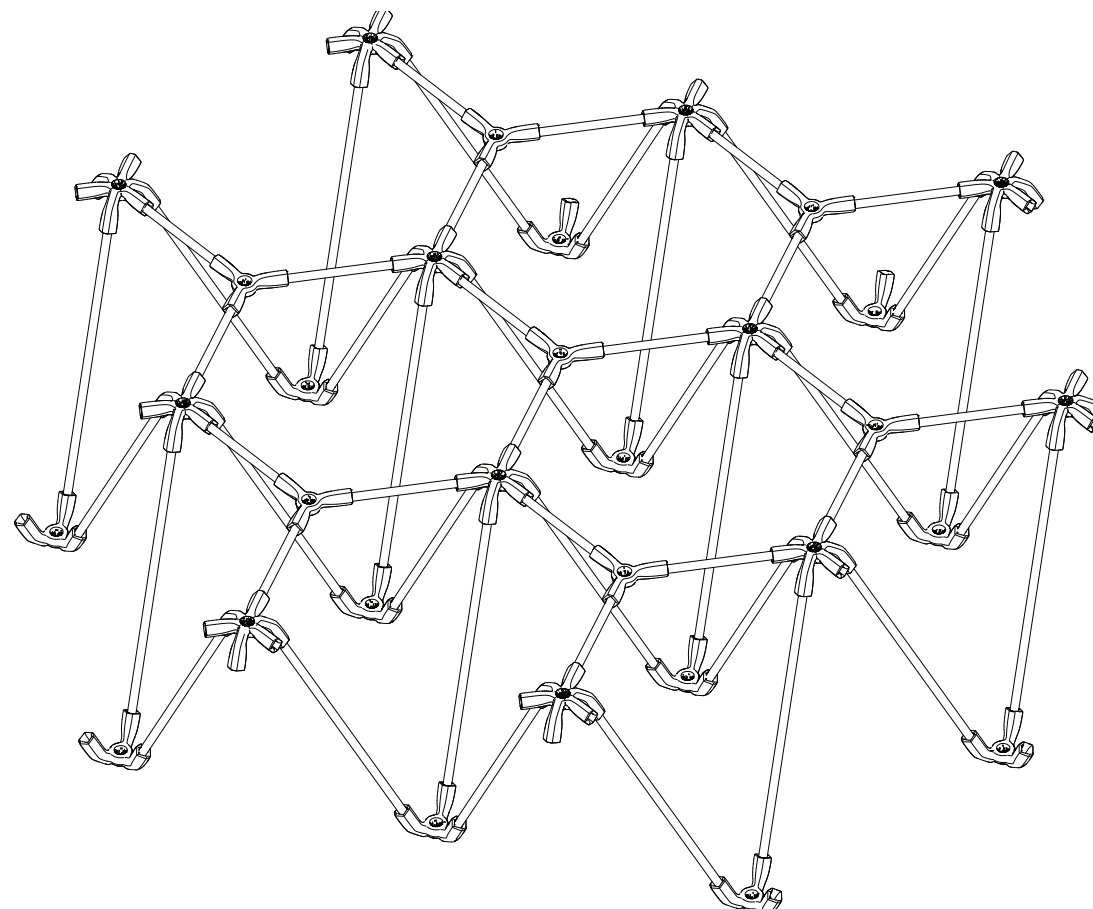

4 Continue extending empty tri and hex hub sockets with 3cm and 6cm bamboo struts

Waffle Assembly



Waffle

-  x 97
-  x 37
-  x 8
-  x 3
-  x 285



1 Start with a pent hub surrounded by bamboo struts

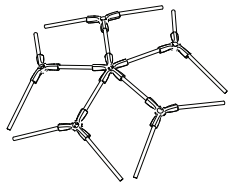

2 Build out 5 tri hubs and 10 bamboo struts

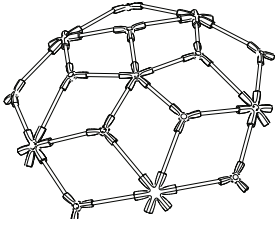

3 Build out 5 hex hubs and extend empty hex hub sockets with tri hubs and bamboo struts

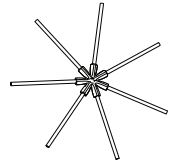

4 Start with a hept hub surrounded by bamboo struts

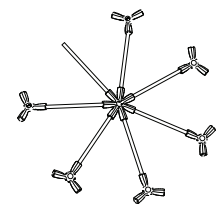

5 Build out 6 tri hubs at the ends of bamboo struts

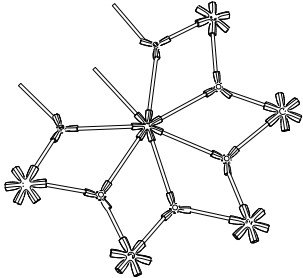

6 Extend empty tri hub sockets and build out 5 hex hubs

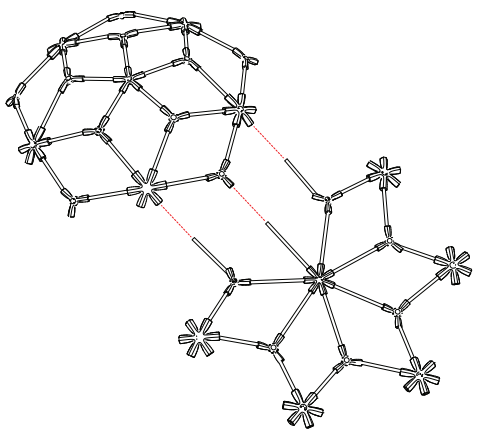

7 Join together assemblies from steps 3 and 6

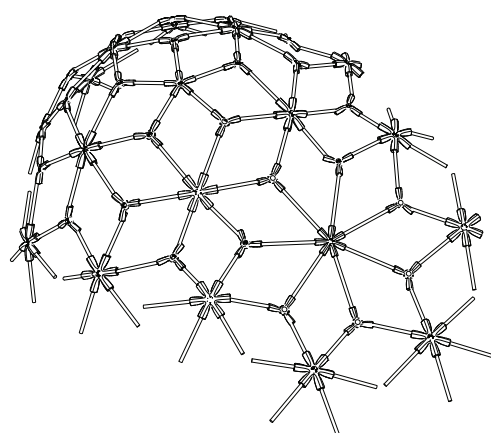

8 Continue extending empty tri and hex hub sockets with bamboo struts

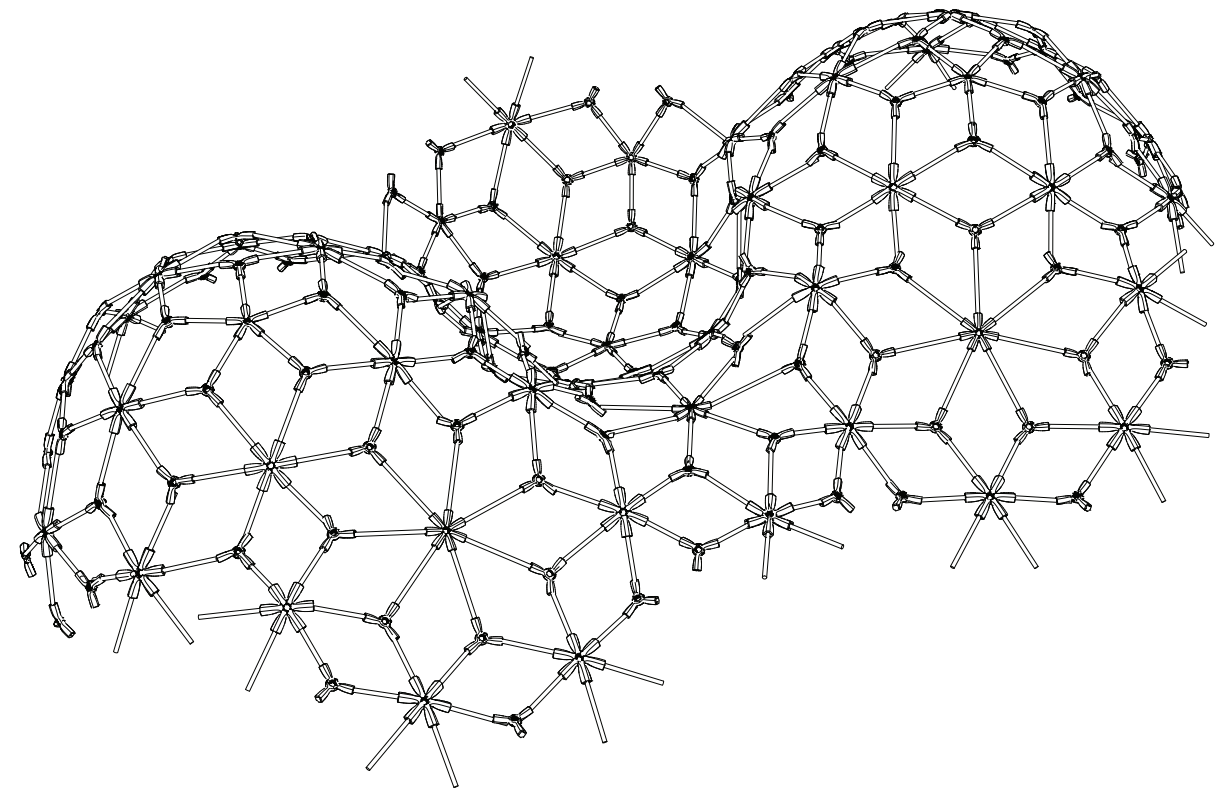

Crenellated Membrane Assembly

Crenellated Membrane

References

Dreamer, David and Jack W. Szostak. *The Origins of Life*. New York: Cold Spring Harbor Laboratory Press, 2010.

Fox, Michael and Miles Kemp. *Interactive Architecture*. Princeton: Princeton Architectural Press, 2009.

“Living Architecture LIAR,” accessed February 2, 2022, <https://livingarchitecture-h2020.eu/>.

Negroponte, Nicholas. *Being Digital*. New York: Vintage Books, 1995.

Oosterhuis, Kas and Xin Xia. *iA #1, Interactive Architecture*. Rotterdam: Episode Publishers, 2007.

Spiller, Neil. *Digital Architecture Now: A Global Survey of Emerging Talent*. London: Thames & Hudson, 2009.

Credits

LASG Executive

Philip Beesley
Timothy Boll
Lisa Jiang
Michael Lancaster
Matt Gorbet
Rob Gorbet
Anne Paxton
Rekha Ramachandran
Alison Thompson

LASG Design & Production

Alexandros Angelidis
Katy Borner
Adrian Chîu
Bria Cole
Filipe Costa
Kevan Cress
Nicolas Désilles
Sebastián González Álvarez
Jonathan Gotfryd
Ilana Hadad
Isabella Ieraci
Ruth Jones
Chris Kang
Lucia Kempe
Bianca Weeko Martin
Mike Nopper
Abida Rahman
Severyn Romanskyy